

PRIMARIO
GRANDE

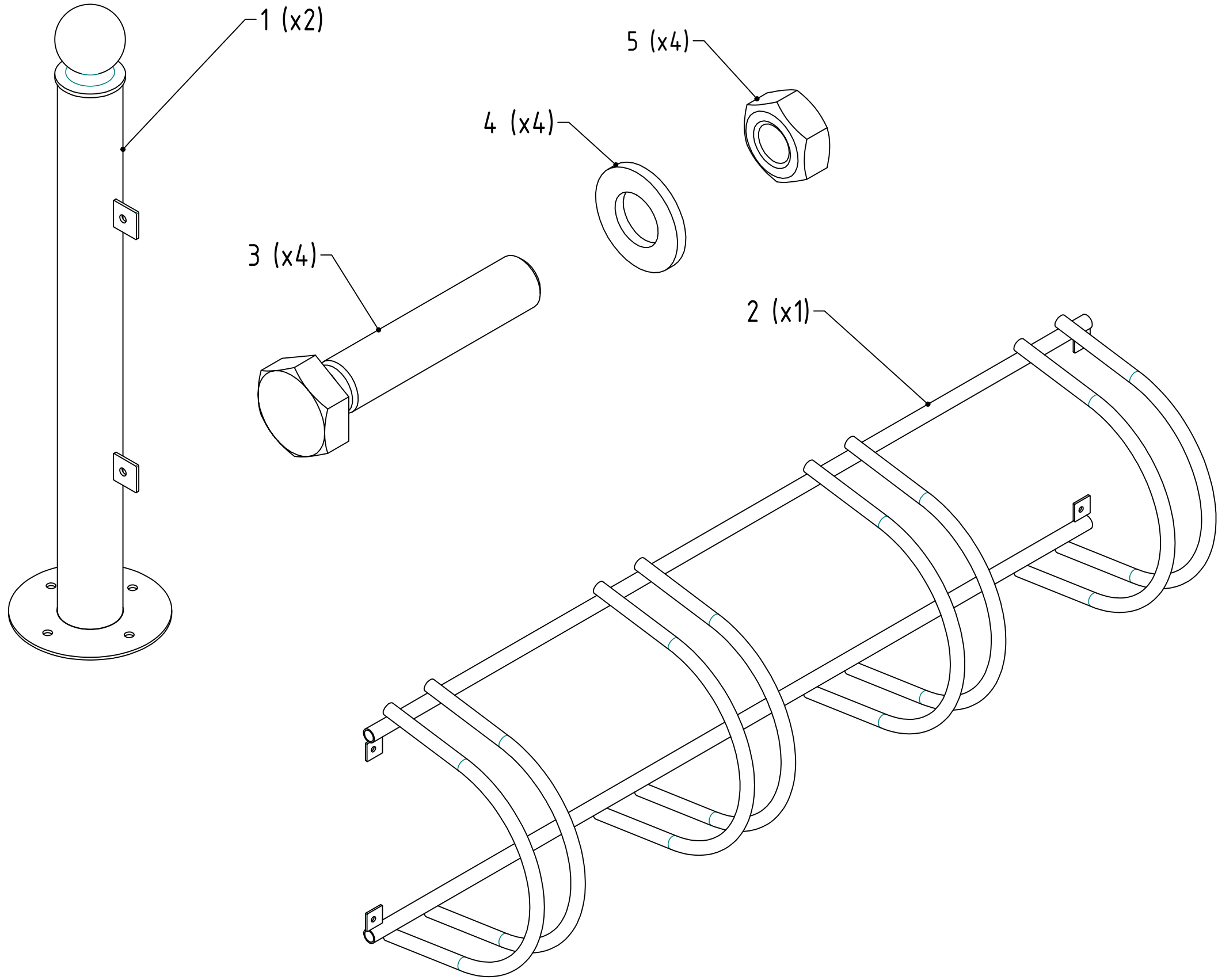

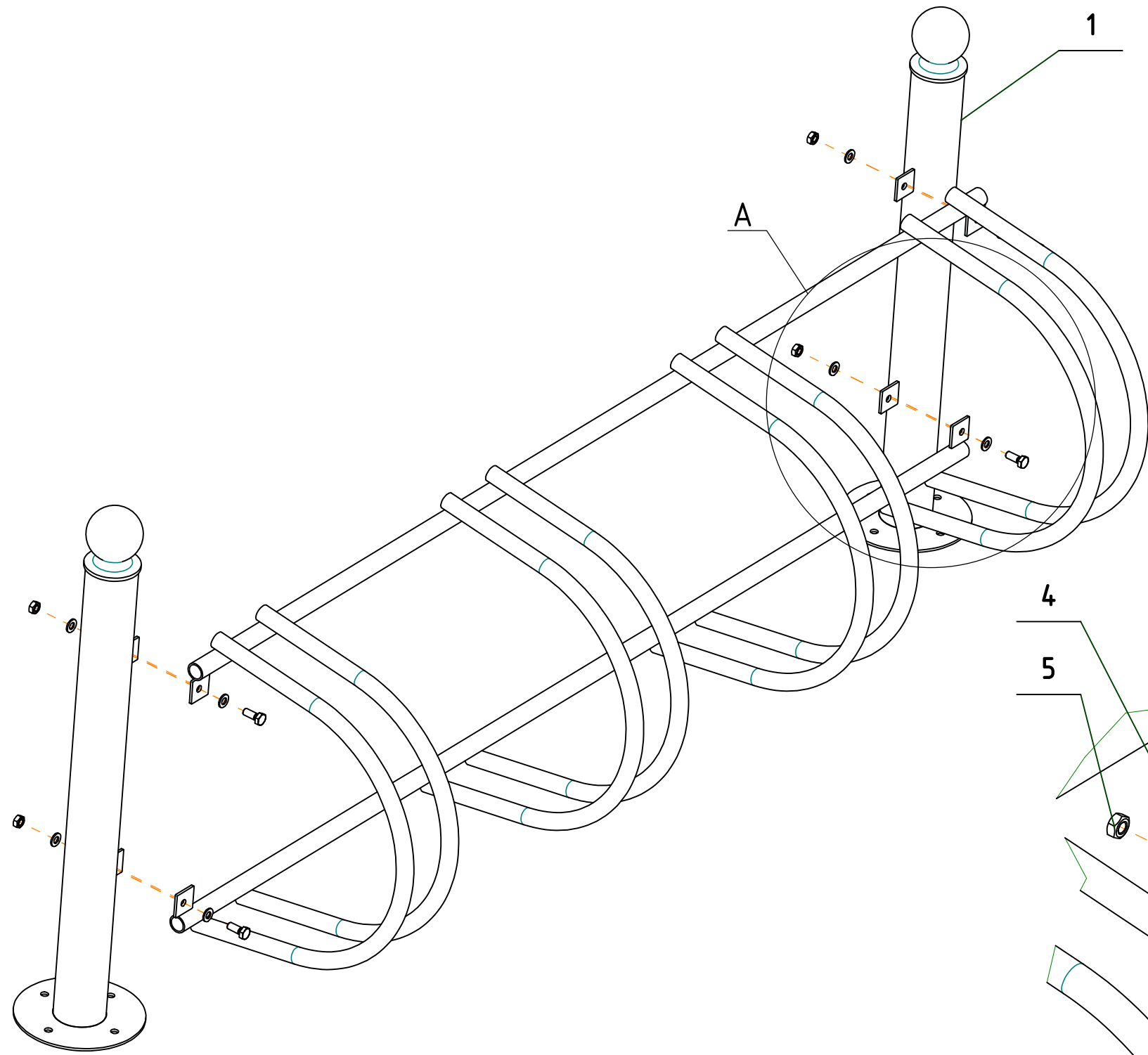

A (1 : 3)

