

PRIMARIO
GRANDE

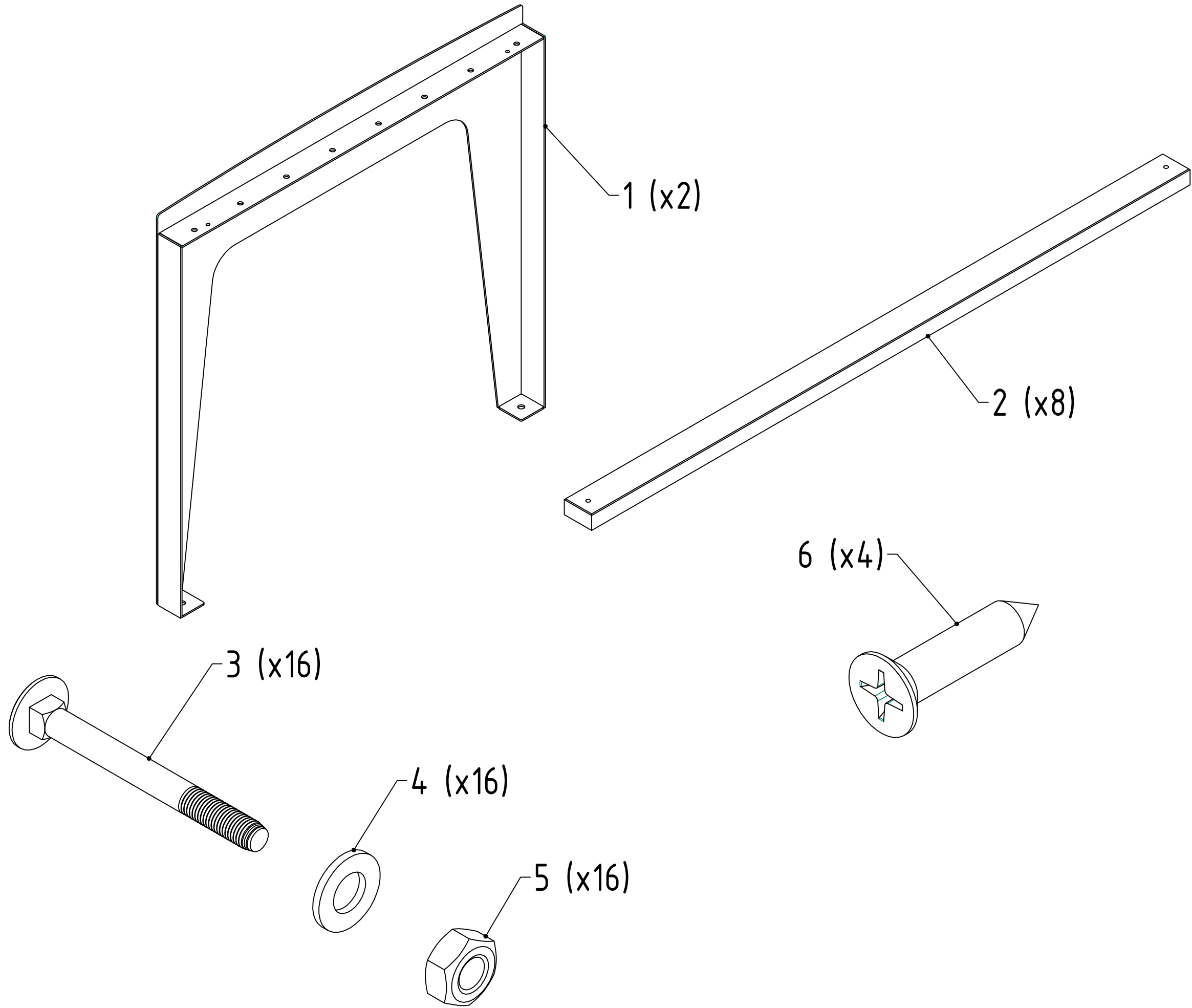

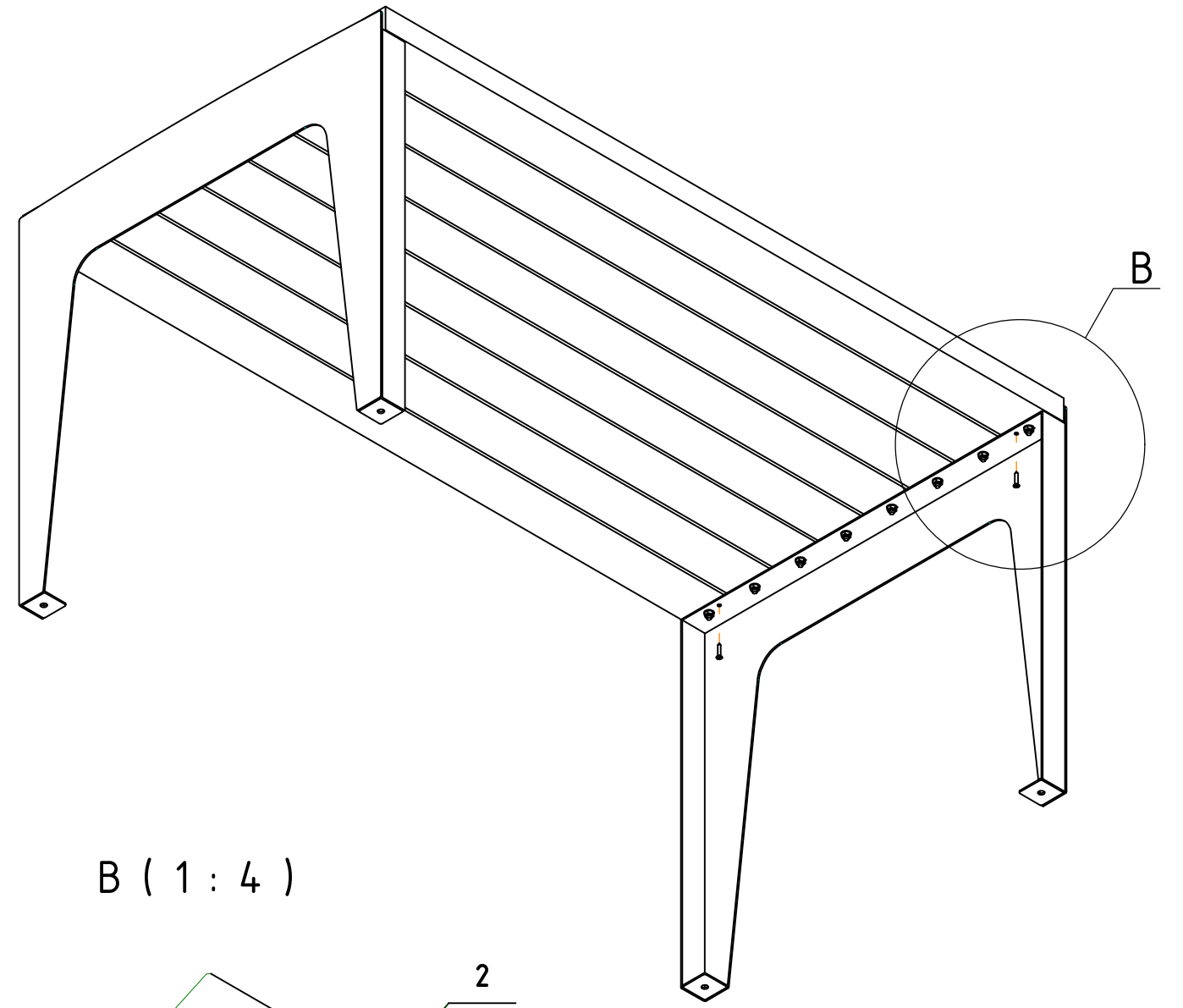
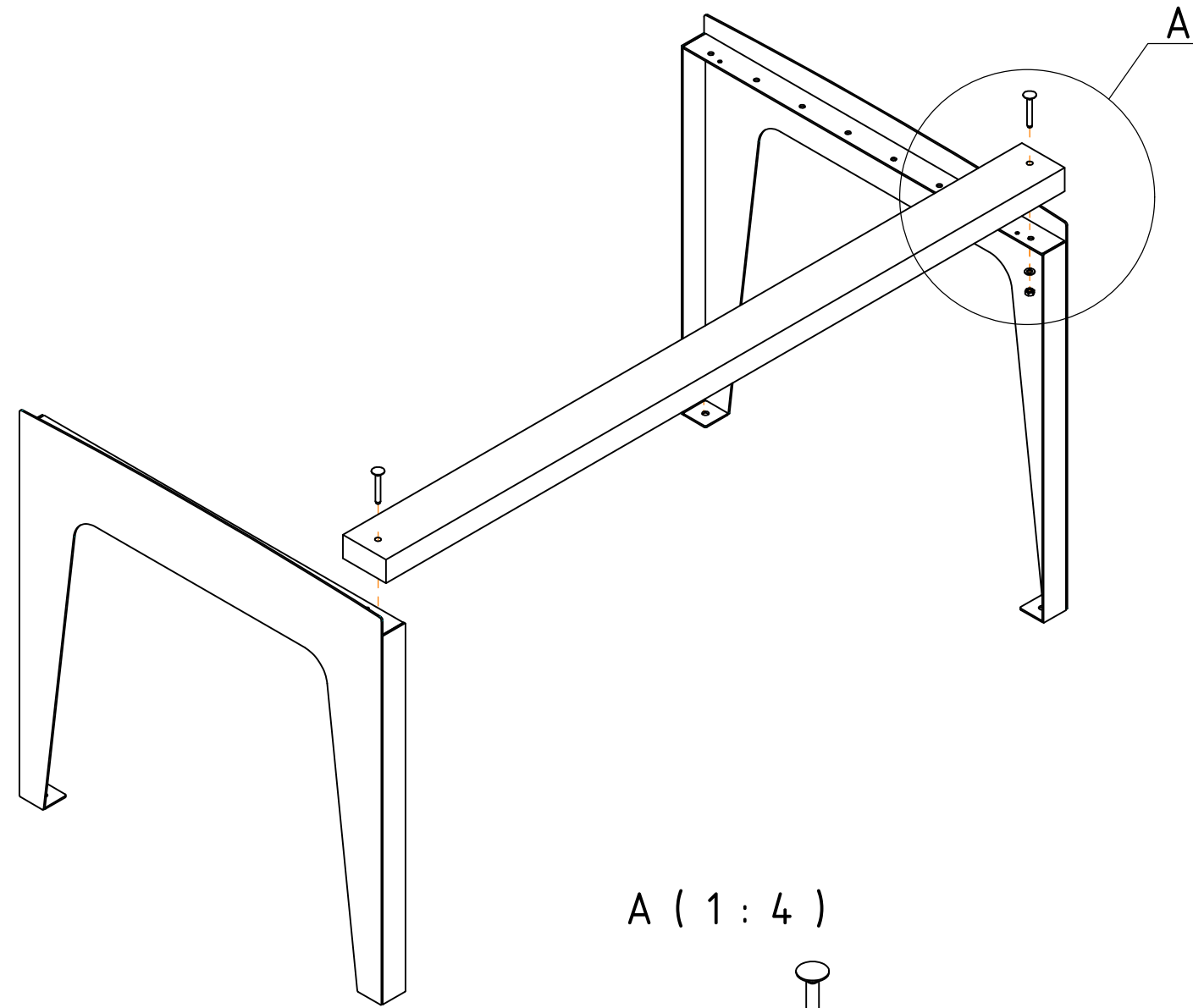

A (1 : 4)

B (1 : 4)

